

20"W x 30"H x 1" THICK
EPOXY RESIN PEGBOARD
W/ 32 PEGS

(ALSO AVAILABLE IN PHENOLIC RESIN)

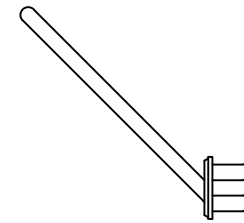

PEG DETAIL
BLACK POLYPROPOLYENE
SCALE- 3X

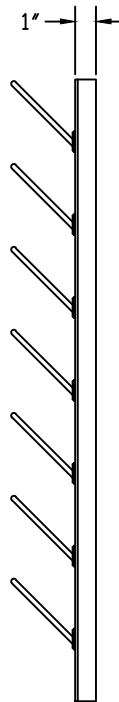
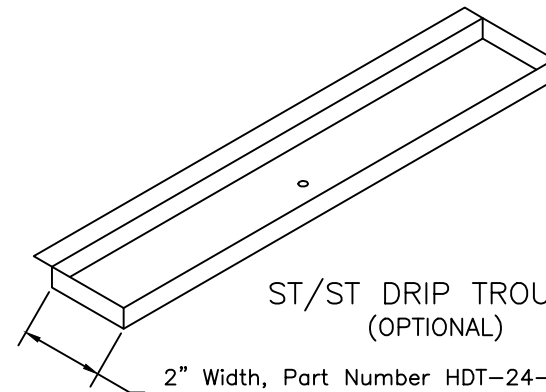

ST/ST DRIP TROUGH
(OPTIONAL)

2" Width, Part Number HDT-24-2
4" Width, Part Number HDT-24-4

Pii PRIME industries, inc.

www.piiab.com

PGBD2030 20" x 30" PEGBOARD

DATE: 8.31.97

REVISED: 4.3.13

DRAWING NUMBER:
PGBD2030